

Refractories for Aluminium

Products Applications

Refrattari per Alluminio

Prodotti e Applicazioni

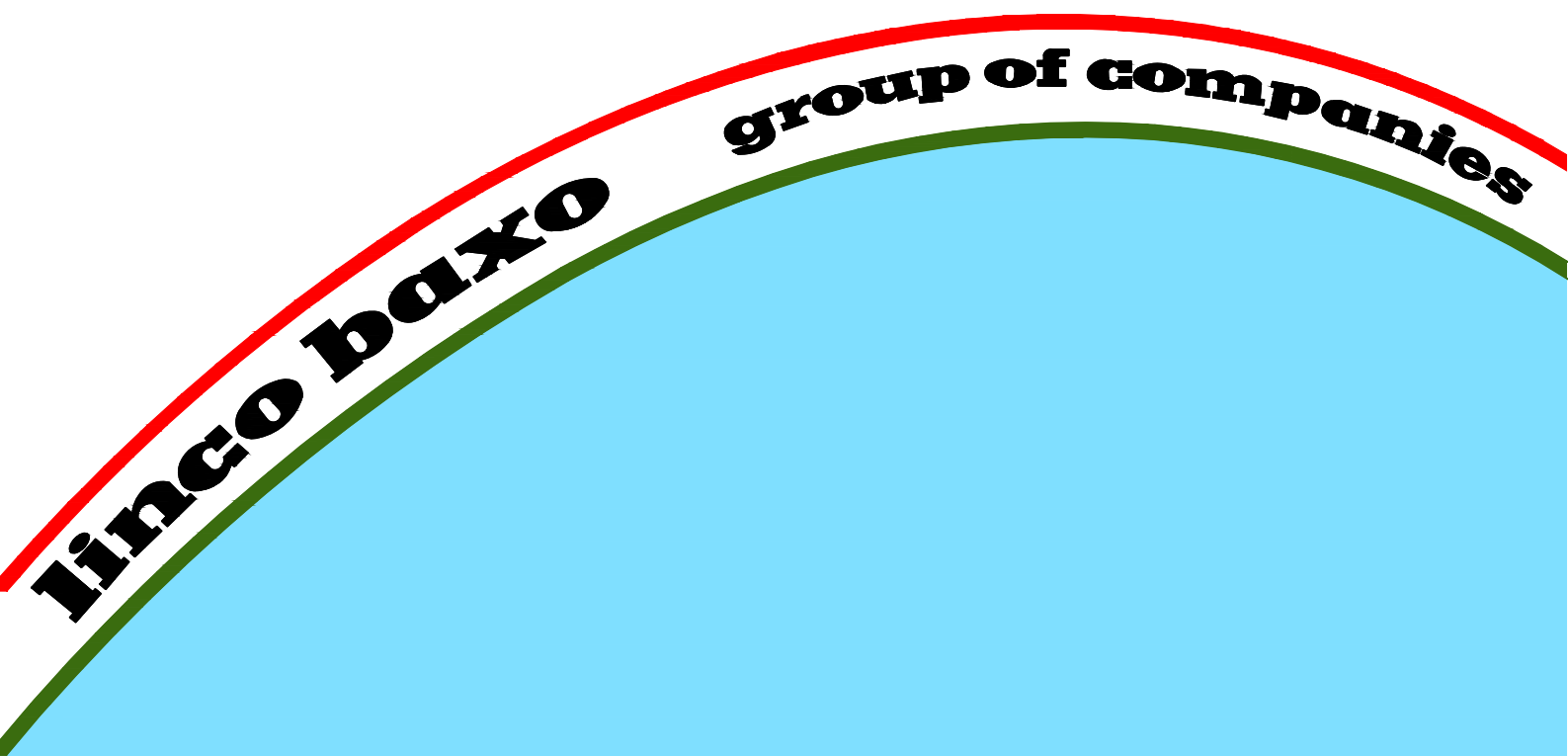

2025 1st issue
second to none
in customer service



refractories expertise,
together since 1949

www.lincobaxo.com

ALUMINIUM PRODUCTION CHART

PRIMARY

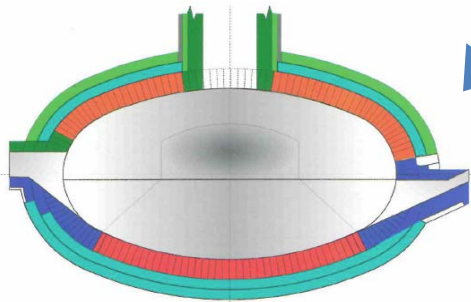
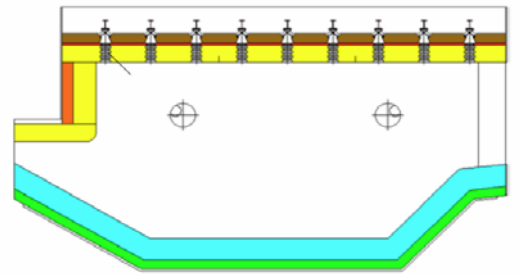
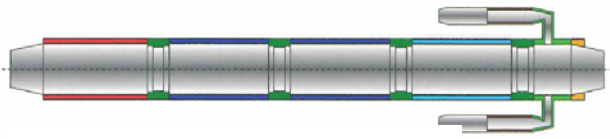
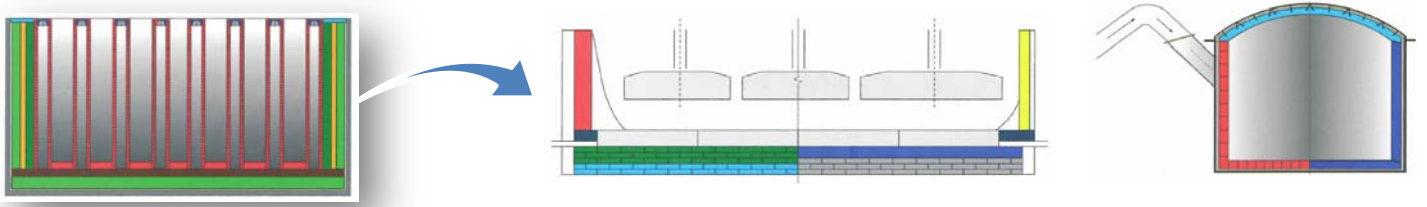

SEMI CONTINUOUS CASTING

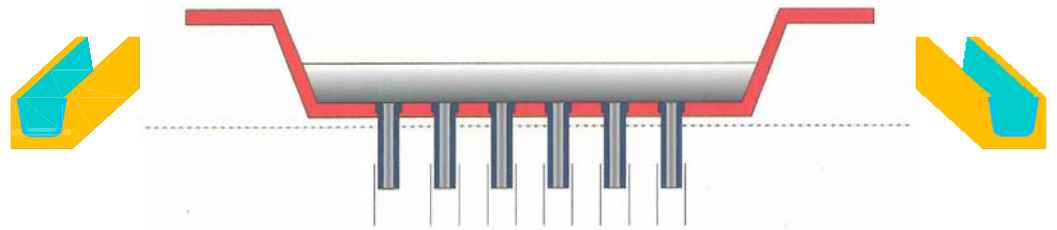

SECONDARY

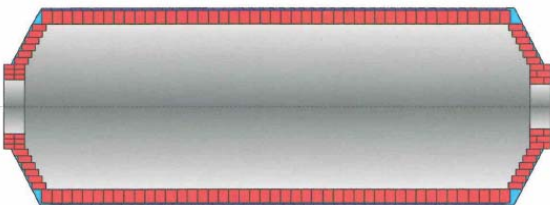
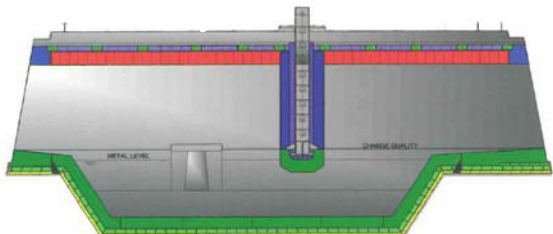

ALUMINA CALCINING KILN

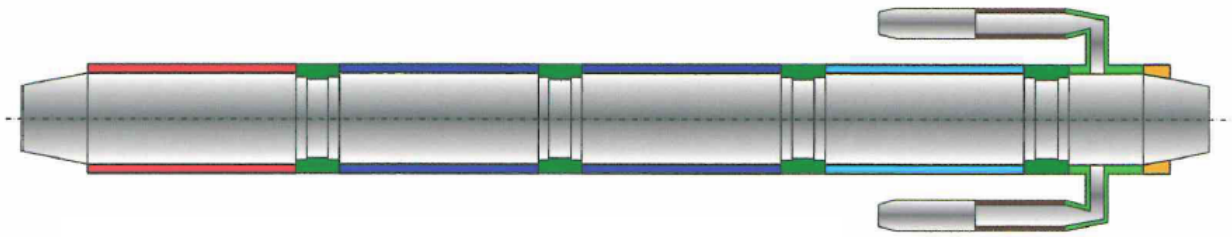

■ SIRBRATE ER C - SIRCAST ER

■ SIRMA 146 SD

■ CL2 - SIRMA 62 ES

■ CL3

■ SIRBRATE ER C - PROMOCAST 58 F5QH

■ CL3

■ SIRBRATE LC 97

ANODE BAKING FURNACE

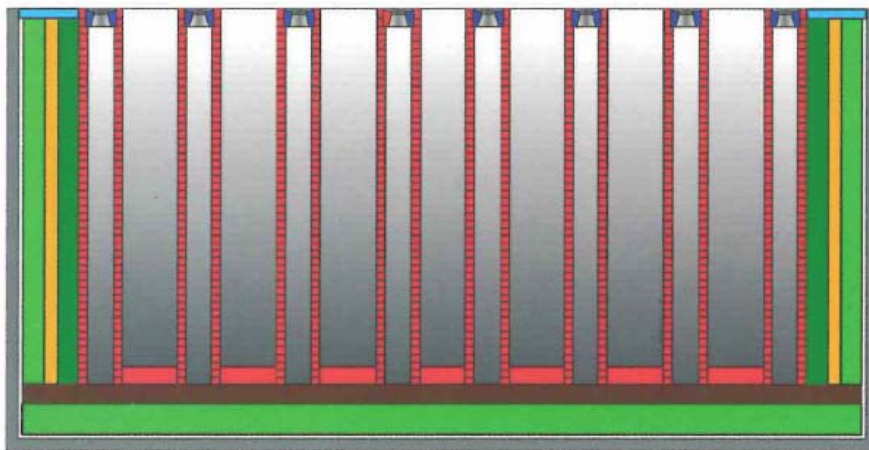

■ SIRMA 147 VA - SIRMA 146 SD

■ PROMOCAST 58 F5QH

■ PROMOISO 125 - SIRLITE 6C - SIRLITE 75

■ SIRMA 146 SD - SIRMA 146

■ ISOM 26

■ ISOM 23

■ ALPOR 50 BT

ELECTROLYTIC POT

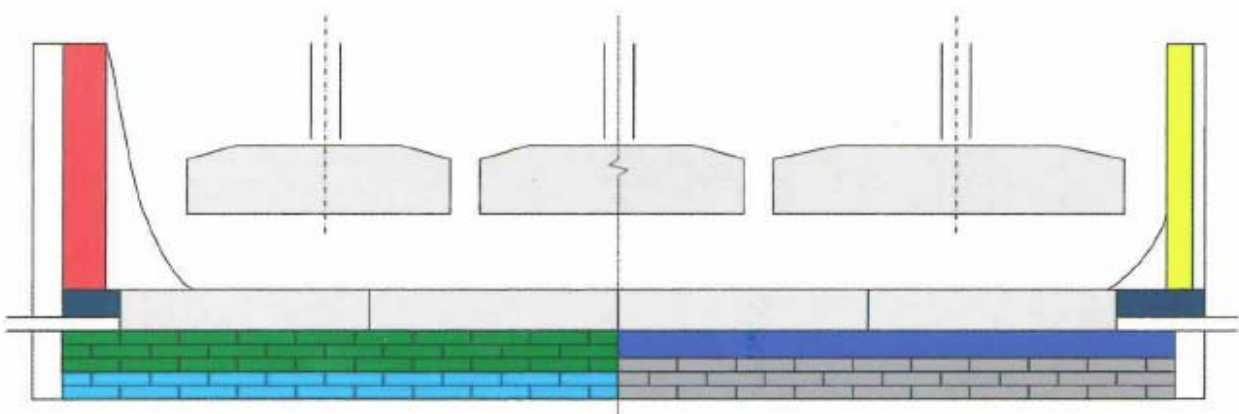

■ ALUSIC N 1

■ CARBON BLOCK

■ SIRMAFLOW 50 ALR

■ SIRMA 145

■ SIRMAFLOW 70 ALR

■ SILTHERM

■ ALPOR 50 BT

LADLE

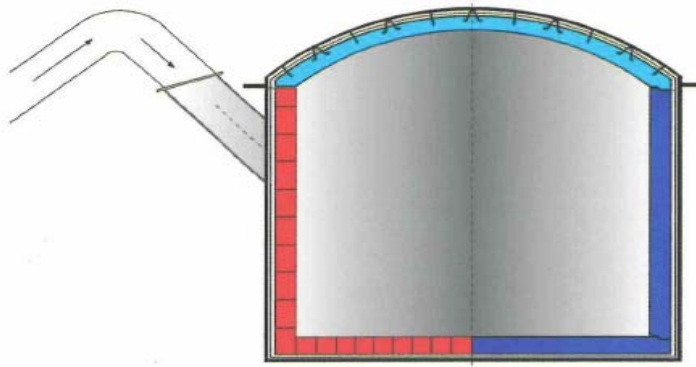

- SIRMA 147 VA
- SIRMAFLOW 80 LC - SIRBRATE LC 85 - SIRPLAST PH85
- PROMOISO 135 AL

ROTARY KILN

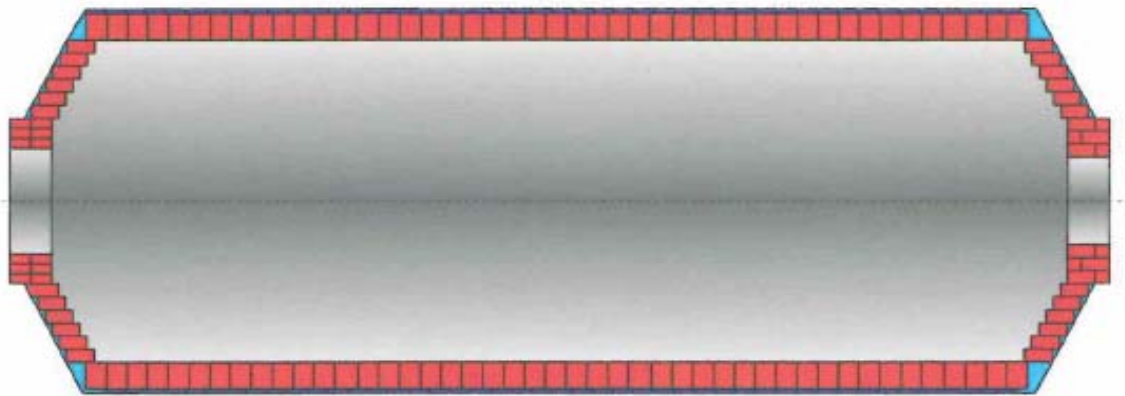

- CL 2
- SIRCAST 42 D

MELTING & HOLDING FURNACE

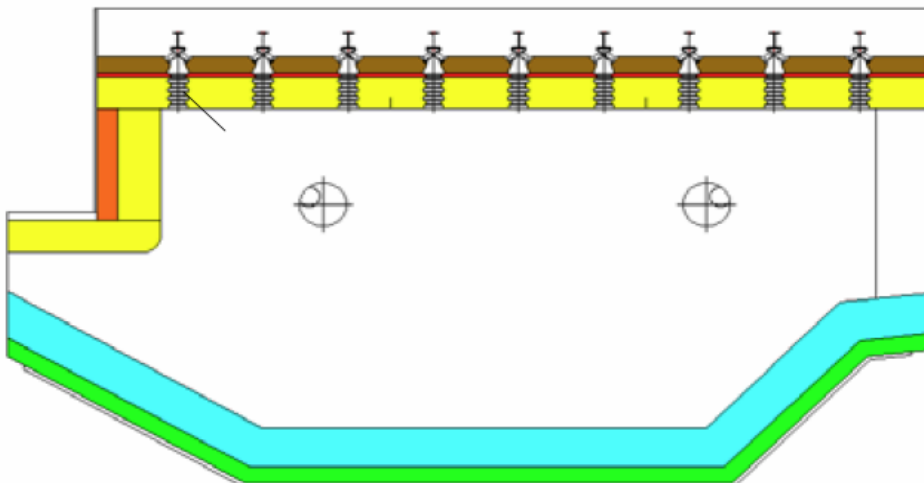

- ALPOR 50 BT
- ALGIB STD / SUPER - LICODRY 60 AL
- PROMOCAST 58 F5 QH
- LV ECO 1200
- ISOM 26
- LICOFEST LW 202 I

TWIN CHAMBER FURNACE (HOLDING - MELTING)

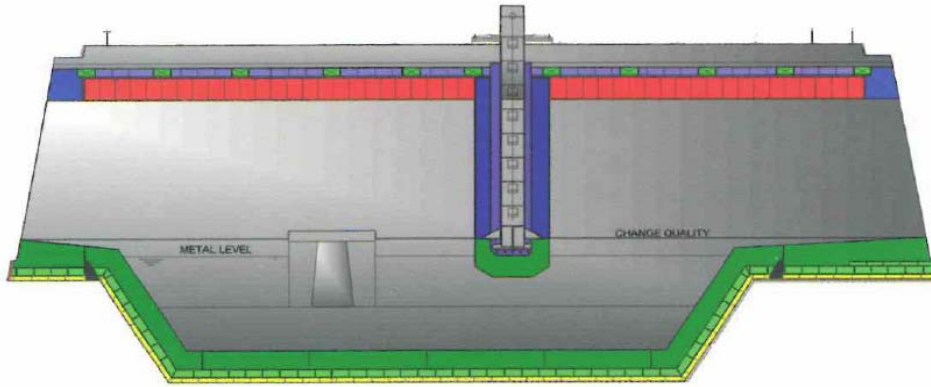

- CL 2
- PROMOCAST 58 F5QH
- SIRMA 145
- ALGIB
- ALPOR 50 BT
- SILTHERM
- ISOM 23

HOLDING FURNACE

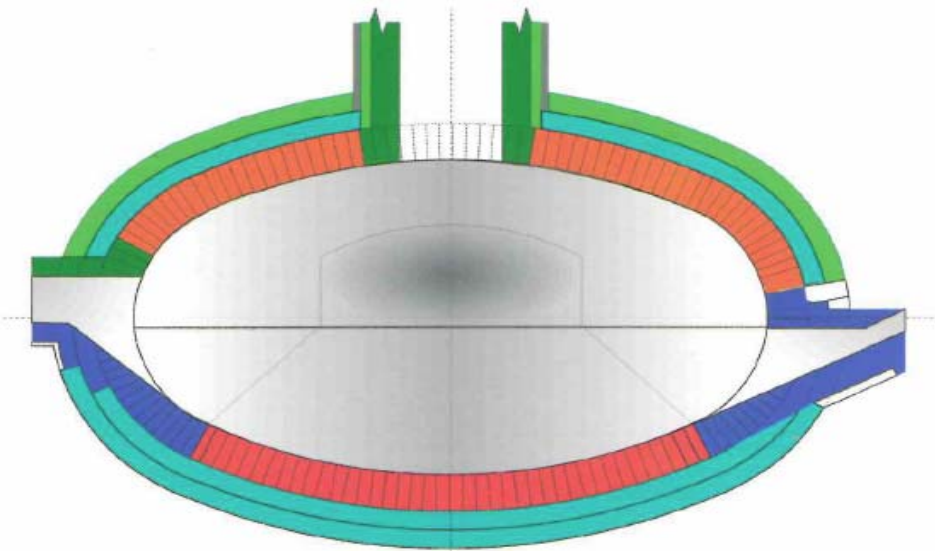

- SIRBRATE LC 85
- SIRMA 85 AL
- SIRMA 146 SD
- PROMOCAST 58 F5QH
- ISOM 26
- ISOM 23
- SILTHERM

SEMI CONTINUOUS CASTING DISTRIBUTORS

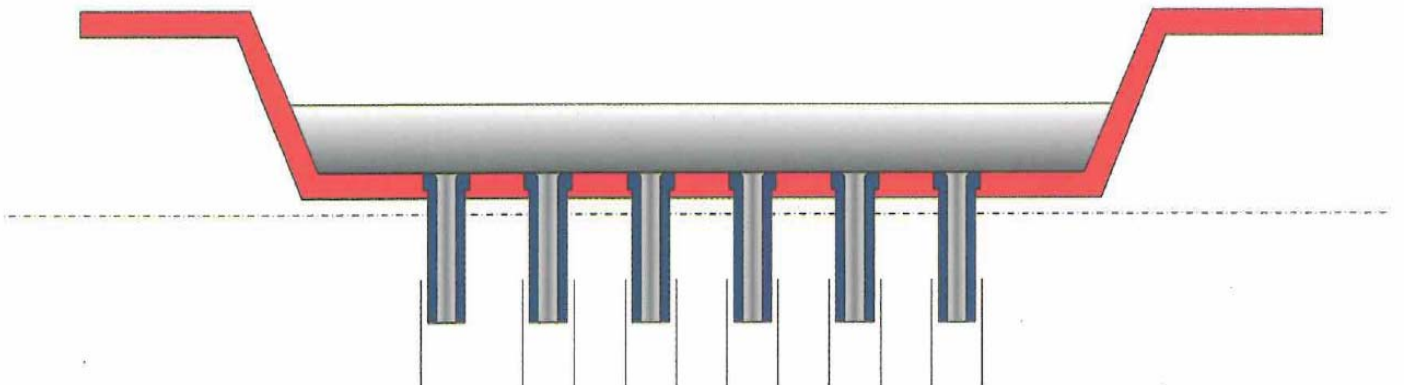

■ SIRLITE 75 - SIRLITE 80

■ HITEK CC 8A

SIRMA : an upgraded range of refractories for the aluminium industry

The Linco Baxo Group of Companies is pleased to present the Sirma range of monolithic refractories, alongside a series of custom-made shapes designed specifically for aluminium producers, refiners, and foundries. All products are carefully tailored to meet the needs of the aluminium industry and are particularly suitable for linings in direct contact with molten metal.

While the melting and holding temperatures of aluminium are lower than those of iron alloys, liquid aluminium and its alloys can still wet, reduce, and corrode refractories, leading to oxidation and the inevitable build-up of corundum.

To address this challenge, Linco Baxo and Sirma have developed a premium-grade series of refractories offering exceptional non-wettability and superior resistance to molten aluminium.

The development of these products has been based on a carefully designed concept, incorporating various raw material combinations and enhanced with special anti-wetting additives. The key choices in this approach are summarized as follows:

- green chrome oxide → Cr₂O₃
- barium oxide → BaO
- calcium fluoride → CaF₂
- zircon → ZrO₂

In collaboration with our customers, we have concluded that each furnace requires a tailored solution, achievable through comprehensive cooperation with the end user. At Linco Baxo, we are fully prepared to address all aspects related to the input data and the furnace process in a thorough and professional manner.

Following an initial assessment with our customers, we can jointly determine the optimal choice for the most effective lining. When required, our laboratory is fully equipped to test the refractory's wettability to aluminium and/or aluminium alloys using a cup test.



REFRACTORY BRICKS & CASTABLES

	Brandname	Chemical Analysis			Classification temperature °C	BD kg/m ³	CCS 1300 °C N/mm ²
		Al ₂ O ₃ %	Fe ₂ O ₃ %	SiO ₂ %			
FIRE CLAY BRICKS	SIRMA 145	42	1,7	-	1380	2300	40
	SIRMA 146 SD	46	1,4	-	1430	2300	55
	SIRMA 147 VA	48	1,2	-	1450	2350	70
ALUMINA BRICKS	CL 2	62	1,5	-	1470	2400	40
	CL 3	81	1,5	-	1500	2800	90
	SIRMA 62 ES	58	1	-	1460	2550	55
	SIRMA 85 AL	83	1,4	-	1520	2800	55
INSULATING BRICKS	ALPOR 50 BT	19	3,5	48	950	500	1
	ISOPOR 0.5	15	4,1	74	900	500	1
	ISOM 23	40	1	56	1320	600	1,5
	ISOM 26	51	0,9	44	1430	800	2,2
SPECIAL BRICK	ALUSIC N1	75 (SiC)	6,8 (N)	-	1480	2630	130
LOW CEMENT CASTABLES	SIRBRATE ER C	47	0,9	1,6 (CaO)	1450	2250	70
	SIRBRATE LC 85	83	1	1,5 (CaO)	1700	2750	100
	SIRBRATE LC 97	97	0,1	<0,1	1700	3050	100
MEDIUM & REGULAR CEMENT CASTABLES	PROMOCAST 58 F5 QH	60	1	3 (CaO)	1600	2500	50
	SIRCAST ER	58	1	7,3 (CaO)	1300	2250	60
	SIRCAST 42 D	43	5,3	12 (CaO)	1300	2050	15
	ALGIB SUP	80	10 (BaO)	3	1450	2760	95
	ALGIB STD	80	10 (BaO)	3	1450	2700	110
INSULATING CASTABLES	SIRLITE 6 C	43	5	9 (CaO)	1370	1400	8
	SIRLITE 75	56	2	3,6 (CaO)	1520	1700	18
	SIRLITE 80	44	1,7	12,5 (CaO)	1370	1250	3,5
	PROMOISO 125 P	41	6,5	10 (CaO)	1260	1350	7
	PROMOISO 135 AL	42	3,2	10 (CaO)	1150	1400	15
	LICOFEST LW 202 I	33	7	13 (CaO)	1100	1200	3,5
SELF FLOWING CASTABLES	SIRMAFLOW 50 ALR	51,2	0,6	10,4 (CaO)	1400	2400	80
	SIRMAFLOW 70 ALR	74	1,1	2,3 (CaO)	1500	2950	120
	SIRMAFLOW 80 LC	80,6	1,1	1,5 (CaO)	1760	2850	120
FAST FIRING CASTABLE	LICODRY 60 AL	64	1	29	1700	2500	>120

The preceding pages offer a brief overview of LINCO BAXO's production in the aluminium market.

Should customers require further information about these products or their applications, LINCO BAXO is pleased to provide specific brochures and detailed data sheets for all brands produced by the company.

LINCO BAXO's strategy is to strengthen and expand its global presence by leveraging the products and market synergies of its renowned brands: LINCO, BAXO, SIRMA, and KERO.

As a leading refractory manufacturer, LINCO BAXO supplies high-quality, specialized products to major refractory-consuming industries worldwide.

LINCO BAXO has always embraced the philosophy of providing not just products, but "Total Refractory Solutions". In this regard, we are committed to meeting all our customers' technical, on-site assistance, installation, commercial, and logistical needs.

● Our Technical-Commercial services include :

A team of skilled sales engineers with expertise in specific industries

A multilingual customer service team with with extensive experience

An installation team comprising experienced supervisors and skilled installers

In-depth analysis of refractory applications, leading to tailored material selection recommendations

A comprehensive refractory design service, including both materials and anchor systems

Technical support for installations

A linings performance review and diagnostic service

Fully equipped refractory laboratory analysis facilities

● Our Logistic Services include :

A testing and pre-assembly area

A spacious stocking area

The potential to transport materials directly from our plants by either, ship, rail or truck

● The customer industries services with LINCO BAXO products include:

→ STEEL

→ ALUMINIUM

→ NON FERROUS METALLURGY

→ MANUFACTURING AND FOUNDRY INDUSTRIES

→ CEMENT AND LIME

→ PETROCHEMICAL

→ CERAMIC, BRICK

→ ENERGY

→ INCINERATION



linco baxo

*refractories expertise,
together
since 1949*

EUROPE CORPORATE HEADQUARTERS:
LINCO BAXO group of companies
Via C.Boncompagni, 51/8 / I-20139 Milano
Tel. +39-02-5520041 / Fax +39-02-5694834
E-mail info@lincobaxo.com
www.lincobaxo.com



linco baxo

*second to none
in customer service*